



BORRIKA[®]

FOR BOATS & KAYAKS

BORIKA® MANUFACTORY



Since 1999, we have been creating high-quality accessories for various types of boats. The factory is located in Ukraine, it provides a full production cycle: from idea to producing of high-quality product.



1

Implement the idea in 3D model

2

Develop technical documentation

3

Do economic calculations

4

Make molds

5

Produce products



HOW IT WORKS

1 Install the mounting system

Check the possibility of equipping types of vessels on pp. 8–13.



2 Choose an accessory and additional parts if needed

It can be extender (pp. 34–35 & 40–43), or adapter (p. 5 & 96–97)

3 Fix the accessory or the assembly in the mount

See two types of locking systems on pp. 6–7.

Combine BORIKA® with products from other brands

The world of BORIKA® is almost unlimited! Our designers have created the whole series of adapters that allow our products be used on vessels that already have mounting systems from other manufacturers. Or vice versa – they will allow the accessories from other brands, for example, spinning rod holders, be fixed into BORIKA FASTen® mounting systems.



Ab038

1.5" (38 mm) ball for sockets of RAM Mounts and other brands



Sb038

Socket for RAM Mounts and any other 1.5" (38 mm) sphere



Da230

Washers between Scotty, Railblaza & BORIKA® splines



Yk015

Transition washers between BORIKA FASTen® and YakAttack side splines



Ap221

Adapter with double fixation with BORIKA® 27.7° splines



ASb027

Adapter for SCOTTY mounting pads (with BORIKA® 27.7° splines)



ARb027

Adapter for RAILBLAZA mounting pads (with BORIKA® 27.7° splines)



ABr027

Transition washer for RAILBLAZA



ABc027

Transition washer for CANNON



UNIVERSAL MOUNT



Universal accessory mount

UNIVERSAL mount (Fs219 model) is included in the assembly of many mounting systems, round rails, support stands. This is the first mount that appeared in the FASTen® line and it can be called a classic, because systems with it are very popular among users, despite the fact that new models with more compact mounts appear. This mount is very reliable and systems with it are designed, as a rule, for higher loads. It is compatible with absolutely any BORIKA FASTen® accessories! The product has a simple locking mechanism: after opening the plug, switch the retainer into the UNLOCK position, insert an adapter of accessory all the way into the mount, and move the retainer into the LOCK position. You can fix the accessory in any position, by rotating the adapter around the axis with 30° increments.

COMPACT MOUNT



Compact accessory mount

The compact mount is available in different assemblies: adapters for the T-Track with bottom or side T-bolt, extended mounts of different lengths, and assemblies for installation on the boltrope of inflatable boats. Such mount is more compact than the one presented on the previous page and has a different locking system based on the ROLL & LOCK principle. To fix the accessory you have to turn the mount body counterclockwise, which moves the retainer to the open position, then push the adapter into the mount all the way in and turn the mount clockwise. It is made of the same materials as the UNIVERSAL mount (fiberglass-reinforced polyamide and AISI 304 stainless steel for fasteners), however, structures with it are usually designed for medium loads. You also can fix the accessory in any position, by rotating the adapter around the axis with 30° increments.

PVC INFLATABLE BOATS & RIBS

The very first accessories under the BORIKA® brand were produced for inflatable boats only. We have extensive experience in equipping this popular watercraft and offer the widest range of products for them.

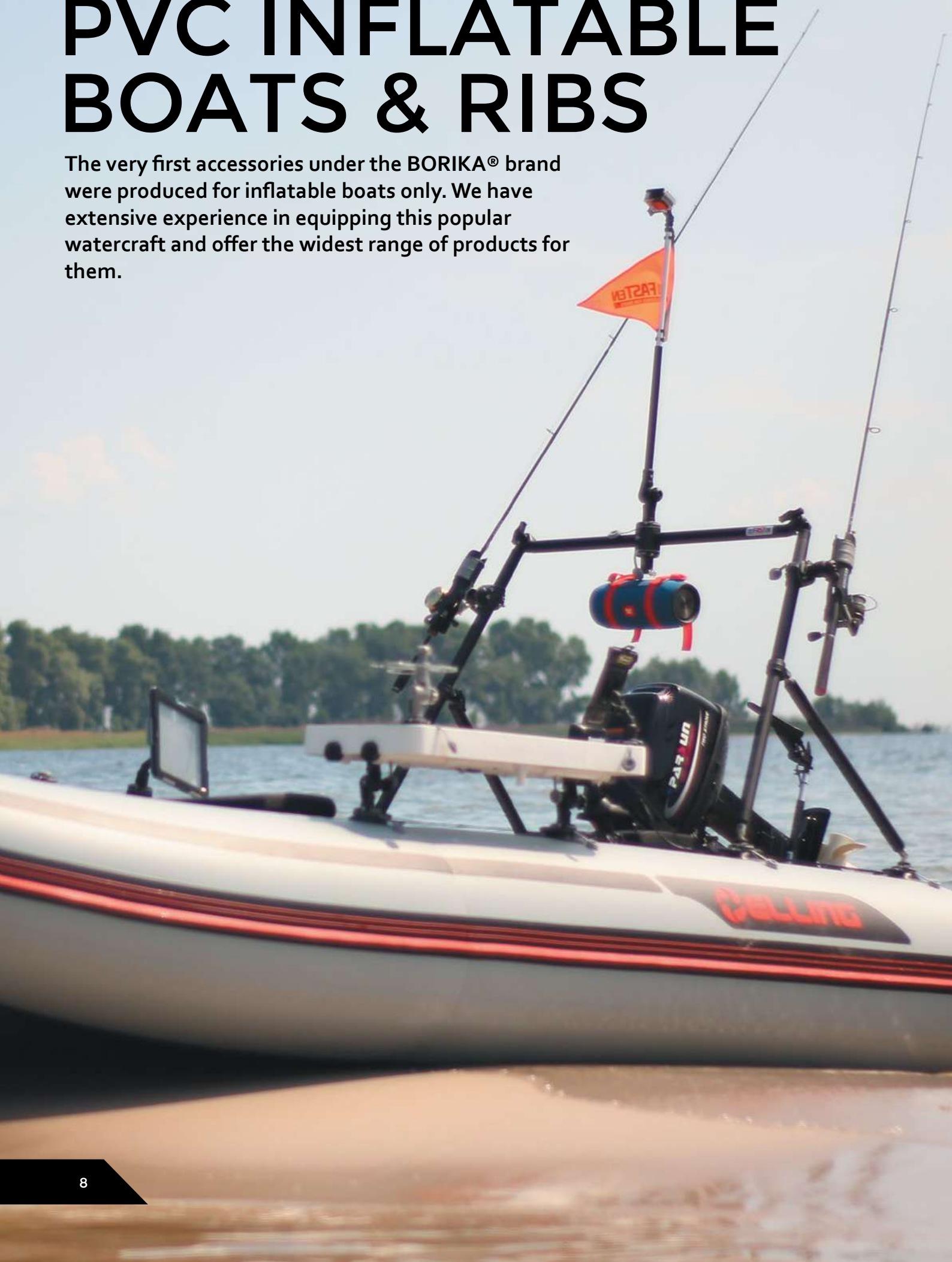



FTp601

Mounting kit for fish
finder and transducer
p. 58–59

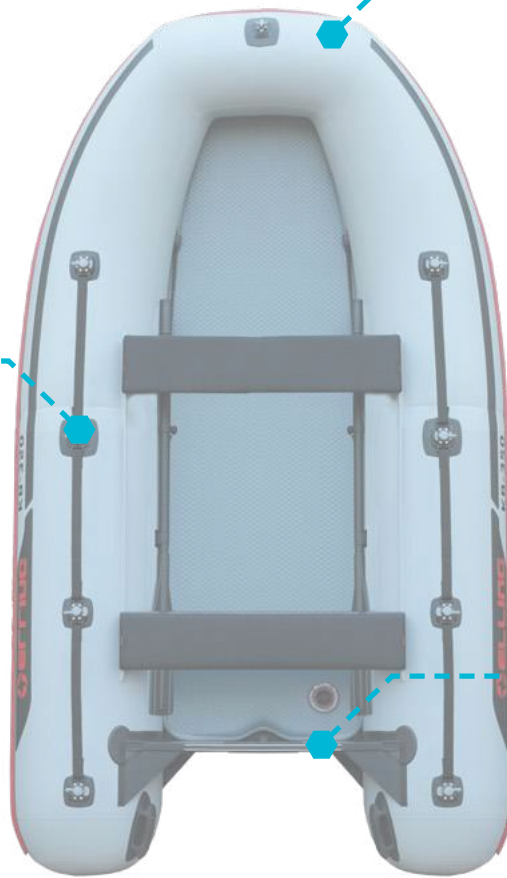

AI004

Anchor lock
p.77

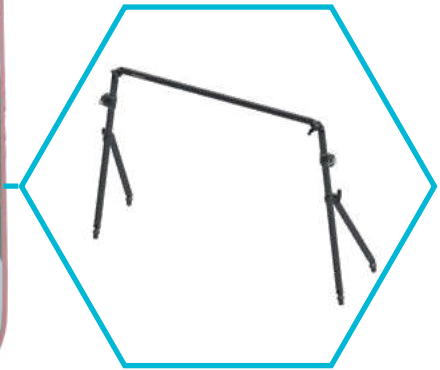

STp110

Trolling Stand
p. 39

Mounting systems for inflatable boats



FMp224
Mounting system,
p. 17



FMp225
Mounting system,
p. 17



FMr132
Mounting system,
p. 31



FMr232
Mounting system,
p. 31



FMx225
Mounting system,
p. 19



Mx
Mounting pad,
p. 19



Mp219
Mounting pad,
p. 18



Fs218
T-Track adapter,
p. 27



FISHING KAYAKS

Equipping any fishing kayak with BORIKA FASTen® products is quick & easy. Use mounting systems with fasteners, systems for T-Track and various T-Track adapters. You can also install one or few round rails with additional mounts.

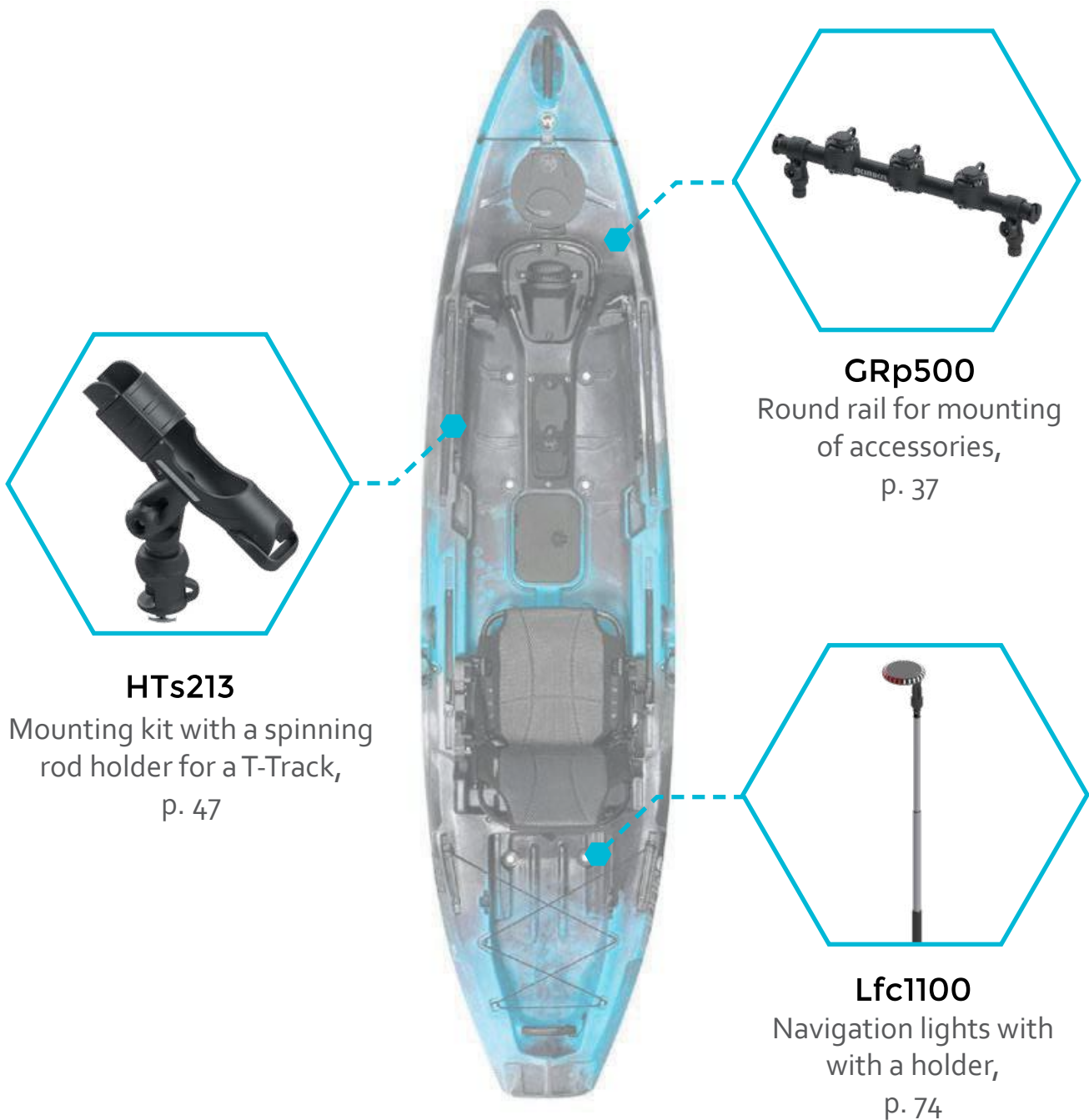

GRp500
Round rail for mounting
of accessories,
p. 37



HTs213
Mounting kit with a spinning
rod holder for a T-Track,
p. 47



Lfc1100
Navigation lights with
with a holder,
p. 74

Mounting systems for kayaks



FMb
Mounting system with
fasteners, p. 23



FFr444
Reinforced mounting
system with fasteners,
p. 23



FMa-2
Mounting system for
T-Track, p. 29



Fs218
T-Track adapter,
p. 27



Fs227
Compact T-Track
adapter, p. 27



Fs223
Mount with a side
T-bolt, p. 27



Mb218
Mounting pad for Fs218
mount, p. 25



TRk150
T-Track pad, 150 mm
length, p. 25

BELLY BOATS (FLOAT TUBES)

In the BORIKA FASTen® line there are a number of accessories that are specially designed for belly boats and take into account the characteristics of float tubes. As a rule, these are products, created to save space inside, allowing you to fix the necessary equipment and devices outside the board.



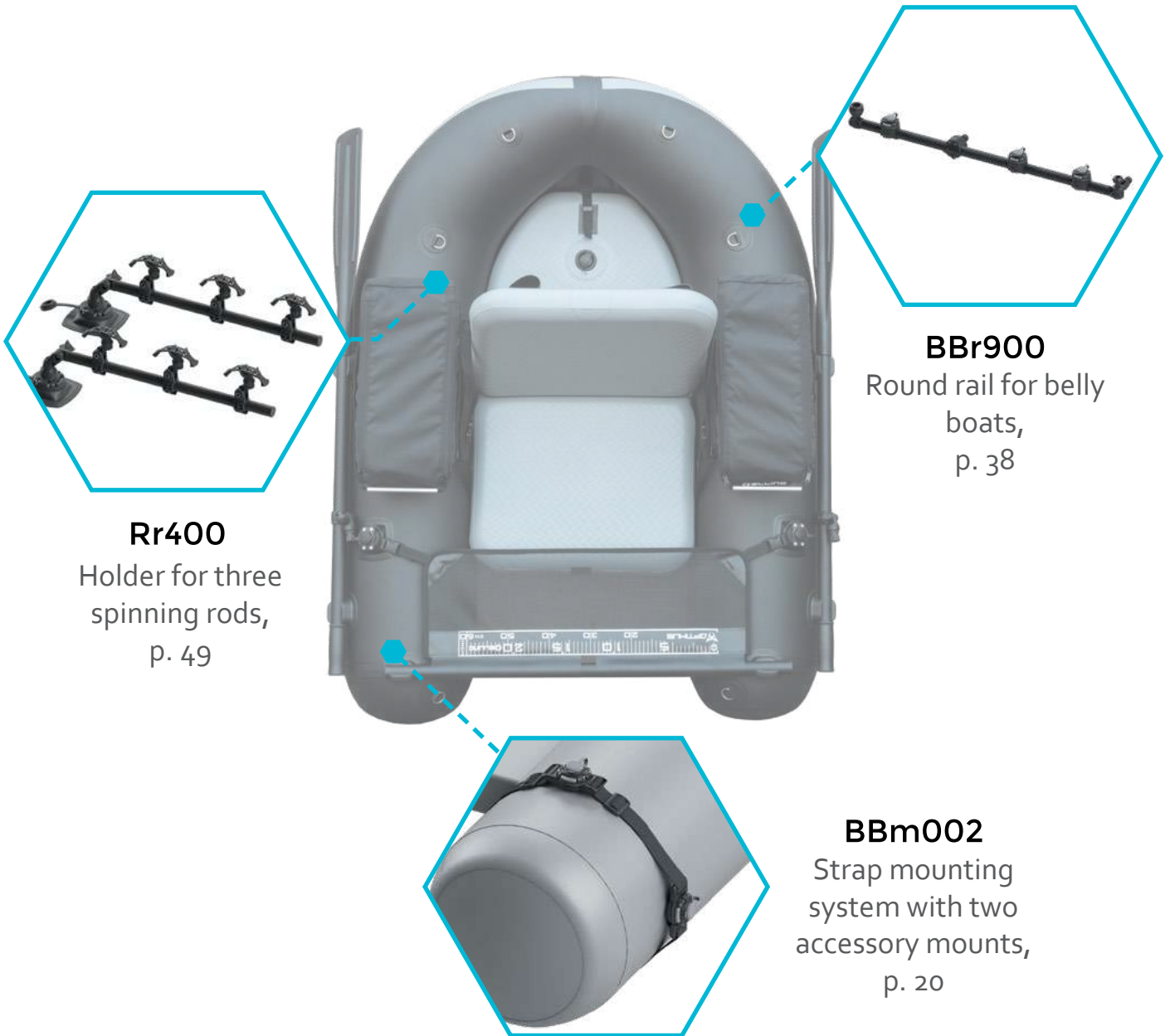

Rr400
Holder for three
spinning rods,
p. 49

BBr900
Round rail for belly
boats,
p. 38

BBm002
Strap mounting
system with two
accessory mounts,
p. 20

Mounting systems for belly boats



FMp224
Mounting system,
p. 17



FMp225
Mounting system,
p. 17



FMr132
Mounting system,
p. 31



FMr232
Mounting system,
p. 31



BBm001
Strap mounting
system, p. 20



Mx
Mounting pad,
p. 19



FMx225
Mounting
system, p. 19



Fs218
T-Track adapter,
p. 27

SYMBOLS & ICONS



for fishing kayak



for rigid boat (barge)



for yacht & aluminium boat



for belly boat (float tube)



for inflatable boat & RIB

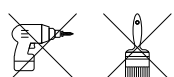

no tools needed for installation



use two-component polyurethane adhesive to glue on



use fasteners to screw on



is equipped with 3M VHB™ tape



can be installed in any system with UNIVERSAL mount



can be installed in any system with COMPACT mount



is designed for light loads



is designed for medium loads



is designed for high loads



fiberglass-reinforced polyamide



anodized aluminium



tube is powder coated



fasteners or other parts are made of A2 grade (AISI 304) stainless steel



parts are made of PVC



made of PVC fabric



parts are made of ABS

TABLE OF CONTENTS

MOUNTING SYSTEMS & PADS

Glue-On mounting systems	16
Mounting systems for boltrope	19
Mounting systems with a strap	20
Clamps & Benches	21
Mounting systems with fasteners	22
Mounting pads with a T-Track	24
T-Track adapters	26
Mounting systems for T-Tracks	28
Mounting systems for tubes & rails	30
Stick-On mounting systems & pads (3M VHB™)	32
Extended mounts	34

EXTENDING MOUNTING SYSTEMS

Round rails	36
Support & trolling stands	39

EXTENDERS FOR ACCESSORIES

Extenders with 27.7° splines	40
Extenders with 15° splines	43

SPINNING ROD HOLDERS

Spinning rod holder	44
Spinning rods holder / rod racks	48

FISH FINDER ACCESSORIES

Premium fish finder plates (AL)	50
Fish finder plates	52
Transducer arm mounts	56
On-board kits for fish finder & transducer	58
Universal transducer arm mounts	60
Fish finder plate & transducer mount	62

CAMERA HOLDERS

Action camera holders	64
Photo & video equipment holders	68

WATERPROOF CASES

70

NAVIGATION ACCESSORIES

72

ANCHOR ACCESSORIES

76

OARS WITH LOCKS

79

TABLES & ACCESSORIES

Fisherman' assistant" tackle plate	80
Modular tables	82
Drink holders	84

LADDERS

86

RIGGING TACKLES

Hooks, rings & bollard	88
Holders with elastic clip	90
PVC mounts with rings & handles	92

MOLLE POUCHES FOR TOOLS & TACKLES

94

ADAPTERS & JOINTS

96

INFORMATION FOR MANUFACTURERS

Individual proposal	98
---------------------	----



GLUE-ON MOUNTING SYSTEMS

BORIKA FASTen® offers a range of mounting systems for all PVC inflatables: motorboats, RIBs, belly boats (float tubes), inflatable kayaks and even SUP-boards. For the installation use a two-component polyurethane boat adhesive. The process is simple, just follow the step-by-step guide, the link to which is below.



Step-by-Step
Installation Guide

Fs219 UNIVERSAL
Mount

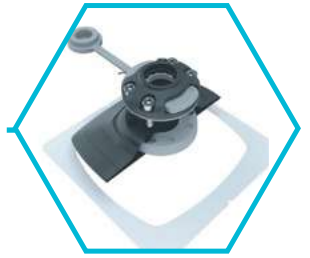

FMp224

PVC mounting system 110 x 110 mm



Youtube
overview



Fs219 UNIVERSAL
Mount



FMp225

PVC system for increased loads 140 x 140 mm



Youtube
overview



MOUNTING PADS FOR FS218 MOUNT

The Fs218 mount with a bottom T-bolt can be installed not only on a T-Track, but thanks to the special pads — on the surface of the inflatable cylinders. All these pads are reinforced with a polyamide insert and differ in the shape (flat or with radius base), and can be glued on the PVC surface with two-component polyurethane adhesive.



Youtube overview

Mp218
Mounting pad (Ø 100 mm) for installation of Fs218 mount

Mp219
Mounting pad (110 x 110 mm) for installation of Fs218 mount



Youtube overview



MOUNTING SYSTEMS FOR BOLTROPE

The boltrope is used to mount movable seats and other accessories on inflatable boats. It is often included in the package. The accessories attached in this way can be easily removed without leaving any marks on the cylinder.



Additional linings for regulation



FMx225

Mount with a pad for the boltrope



Mx

System for mounting on the boltrope



Youtube overview

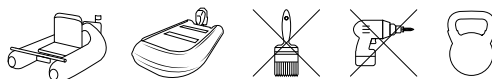

MOUNTING SYSTEMS WITH A STRAP

Are useful for belly boats (float tubes)



Youtube overview



Installation guide

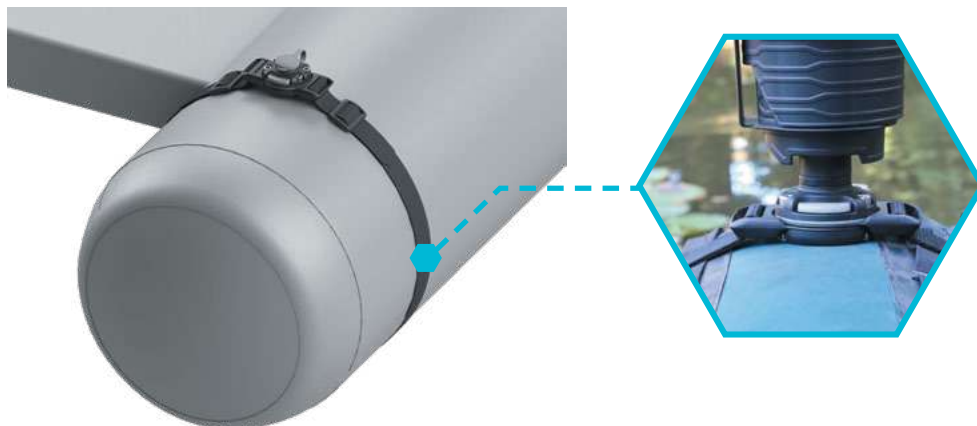

BBm001

Strap mounting system with one accessory mount

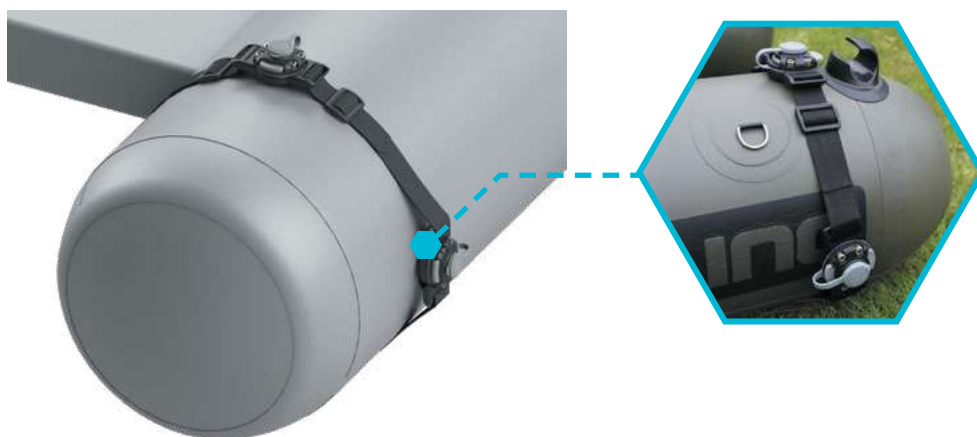

BBm002

Strap mounting system with two accessory mounts

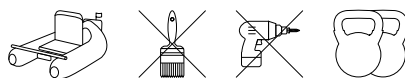

CLAMPS & BENCHES



FMk-2

Two accessory mounts in the assembly with bench mounting pad



Youtube overview



FMc

Accessory mount in the assembly with clamp mounting pad

FMc-2

Two accessory mounts in the assembly with clamp mounting pad



Youtube overview

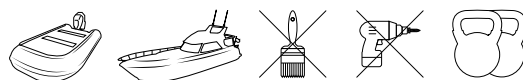

MOUNTING SYSTEMS WITH FASTENERS

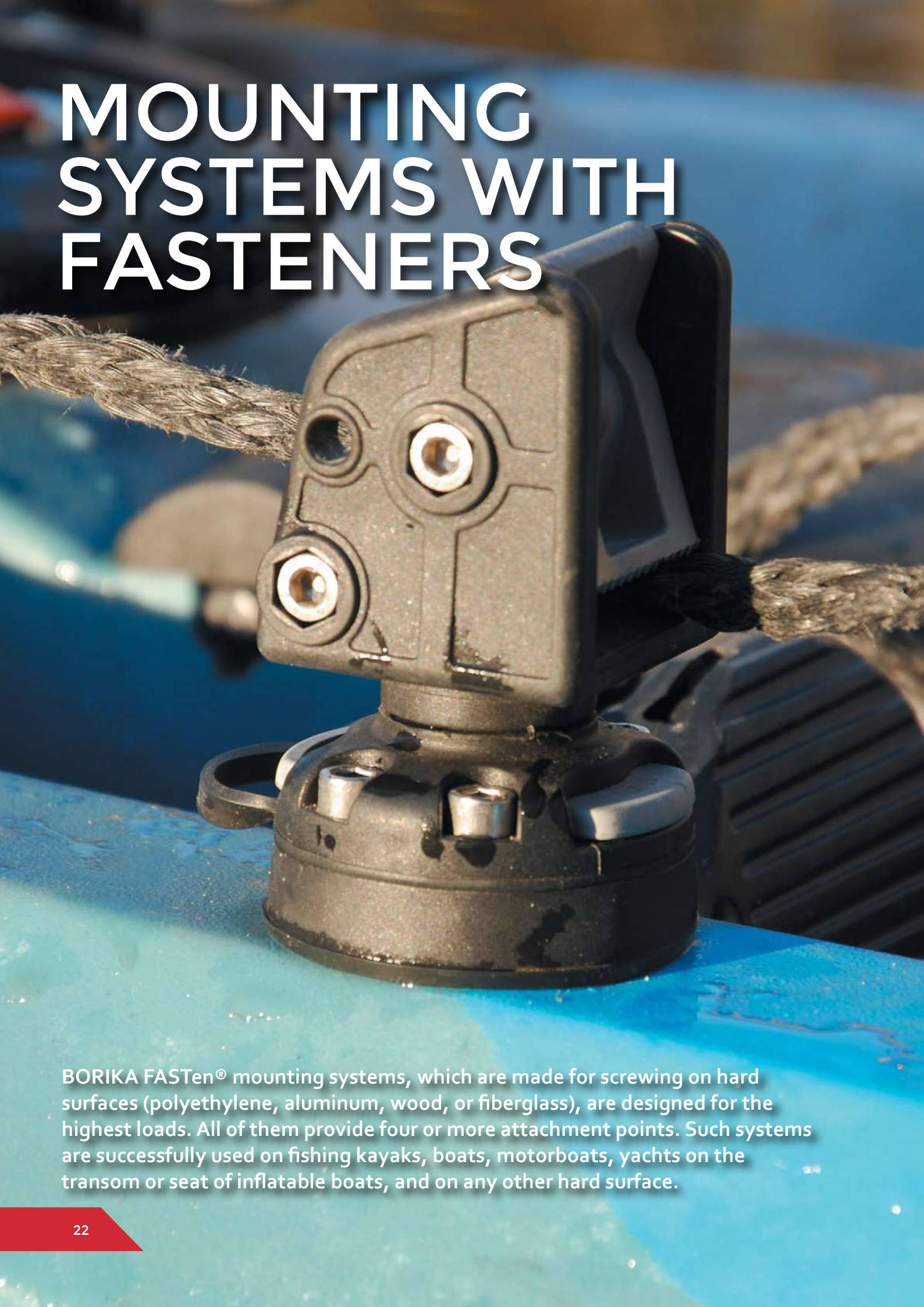

BORIKA FASTen® mounting systems, which are made for screwing on hard surfaces (polyethylene, aluminum, wood, or fiberglass), are designed for the highest loads. All of them provide four or more attachment points. Such systems are successfully used on fishing kayaks, boats, motorboats, yachts on the transom or seat of inflatable boats, and on any other hard surface.

Fs219
UNIVERSAL Mount



4 attachment
points



Youtube
overview



Step-by-step
installation guide

FMb

System with \varnothing 62 mm pad



Suits for rectangular niches
on kayaks and boats



FFr444

System with 110 x 53 mm pad

Can be installed on Scotty mounting
pads: 341 Glue-On mount & 449
Portable Clamp Mount, in place of
241 Combination Side



Youtube
overview



Step-by-step
installation guide

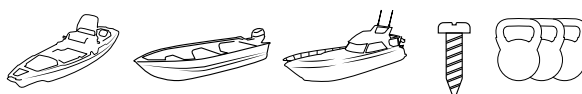



MOUNTING PADS FOR T-TRACK MOUNTS

To install T-Track mounts on hard surfaces of boats & kayaks use BORIKA FASTen® mounting pads with fasteners. They can be easily installed with self-tapping screws already provided in the package.



Mb218
Round pad
for the Fs218 mount



TRk150
T-Track, L — 155 mm



TRk255
T-Track, L — 255 mm



Fasten this pads together
with MOLLE pouches,
see pp. 94–95.



T-TRACKS ADAPTERS



Mounts with T-bolts (T-Track adapters) allow you to equip a kayak or motorboat (yacht) with any accessories from the catalog. They are COMPACT and easy to use, yet just as reliable as the “classic” UNIVERSAL mount. They do not require additional tools for installation and are easily dismantled.



For installation on various surfaces additional pads are provided. See p. 18, p. 25, p. 33

Fs218

With bottom T-Bolt
Good for a T-Tracks, directed upwards



Youtube overview

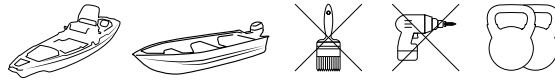

Can be installed on plugs of round rails, see p.37



Fs223

With side T-Bolt
(good for a T-Tracks, directed inside the boat)



Youtube overview



Ø 48 mm height & 41 mm in diameter

Fs227

The super compact mount



Youtube overview



MOUNTING SYSTEMS FOR T-TRACKS

Mounting systems for installation on a T-Track with an FS219 mounts are designed for higher loads due to the four attachment points of the mount to the pad and two T-bolts. All of them can be comparing with one T-bolt on T-track adapters successfully used both on kayaks and on motorboats (yachts) with tracks, directed upwards or inside the boat.





Youtube overview

FMa

System for vertical installation
Good for any T-Track of motorboat or kayak



FMa-2

T-Track system with two mounts



FFr222

System for horizontal installation



Youtube overview

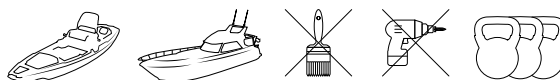

MOUNTING SYSTEMS FOR TUBES AND RAILS

BORIKA FASTen® mounting systems are suitable for installation on tubes & rails with a diameter of 22, 25, 30 or 32 mm. A properly installed system does not twist round or slide along the rail, even if used with high loaded accessories: an anchor lock or spinning rod holder during trolling.

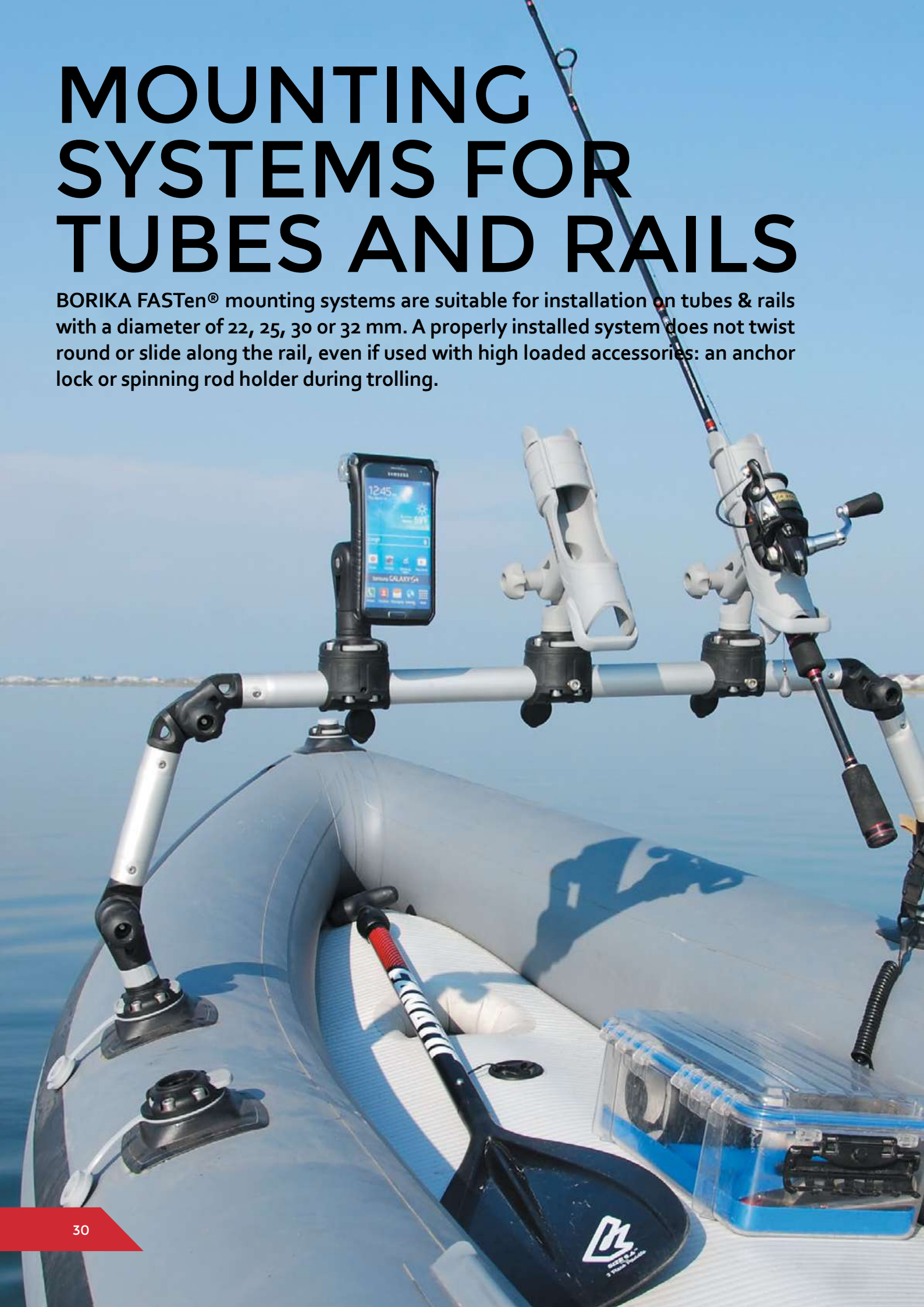

Fs219 mount with four attachment points

Side screws for rigid installation



The system of this model is included in the assembly of all round rails and troling stands presented in this catalog and can be used to complete them with additional mounts.

Elastic liner for Ø 30 mm tubes



Youtube overview

FMr132

System with one mount for Ø 30 or 32 mm tubes



FMr232

System with two mounts for Ø 30 or 32 mm tubes



FMr125

System with one mount for Ø 22 or 25 mm tubes



FMr225

System with two mounts for Ø 22 or 25 mm tubes



STICK-ON MOUNTING SYSTEM AND PADS

Mounting systems with 3M VHB™ tape can be installed on the vessel in a few seconds. They can be stuck on different hard flat surfaces (except for polyethylene ones).

Pay attention, that these pads are never used on PVC inflatable cylinders! On inflatables are much more reliable PVC systems, glued with two-component polyurethane adhesive. They also are not secure on polyethylene surfaces. So use all pads with 3M™ VHB™ tape only on polyurethane, aluminium, fiberglass or laminated wood surfaces.



FMs224

System for quick installation
with Fs219 mount
(for hard flat deck or side only)



Youtube
overview



Ms220

Pad for installation of Fs218 T-Track adapter
(for hard flat deck or side only)



Youtube
overview





EXTENDED MOUNTS

Extended mounts are an opportunity to fix absolutely any accessories at some distance from the attachment point on the vessel, even those that are not equipped with tilt spline joints.



FAv210

Accessory mount in the assembly with swivel-tilt adapter



FEx100

Accessory mount in the assembly with plastic extender (L — 100 mm)



FEx220

Extended tilt mount (L — 205 mm)



FAe220

Extended mount (L — 220 mm)



FEx250

Extended mount (L — 250 mm)





ROUND RAILS

BORIKA FASTen® round rails are extending mounting systems that help you organize space on the boat, keeping all the necessary accessories & equipment compactly and at hand. One or two pre-installed mounting systems are sufficient for their installation. Round rails increase the number of attachment points and allow you to securely fix more useful accessories.



Ø 32 mm, protecting anode layer & powder coating

RLp032 fully adjustable collars

Plug for additional Fs223 mount

GRp500-3

Round rail
Ø 32 mm, L — 500 mm



Youtube overview

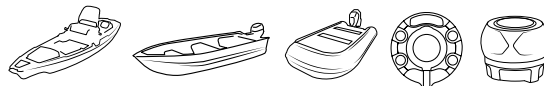

Gm350-3

Round rail
Ø 32 mm, L — 350 mm



Youtube overview

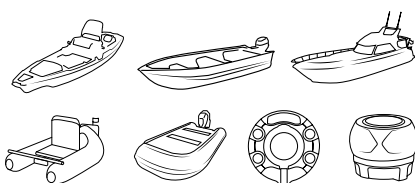

GRp700-3

Round rail
Ø 32 mm, L — 700 mm



Youtube overview

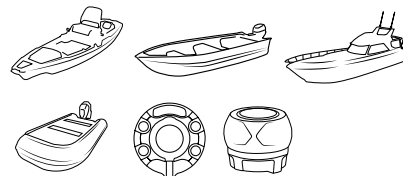



Youtube overview



BBr900

Round rail for belly boats

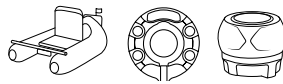

SUPPORT & TROLLING STANDS



STp080

Support & trolling stand

Ø 32 mm, L — 80 cm

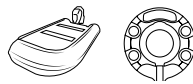

STp050

Support stand

Ø 32 mm, L — 50 cm



STp110

Support & trolling stand

Ø 32 mm, L — 110 cm



STp140

Support & trolling stand

Ø 32 mm, L — 140 cm

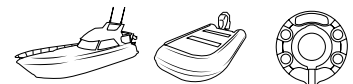

EXTENDERS FOR ACCESSORIES

When it is necessary to raise the accessory above the installation surface, extenders are indispensable. The extenders on these pages are equipped with side splines and are suitable for assembling constructions with different tilt accessories. There are two types of extenders: with 27.7° and 15° splines.





Ex100

Plastic extender for accessories
(L — 100 mm) with 27.7° splines



Ex160

Extender for accessories
(L — 160 mm)
with 27.7° splines



Ex225

Extender for accessories
(L — 205 mm)
with 27.7° splines



Ex325

Extender for accessories
(L — 305 mm)
with 27.7° splines

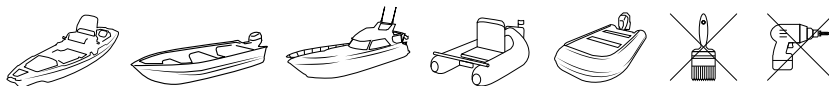

EXTENDERS FOR ACCESSORIES

Any accessory with 27.7° side splines can be extended by 610 mm with these two models. The difference between them is that one has an additional tilt spline joint in the middle and can be fixed in an inclined or even folded position.



Ex632

Extender
(L — 610 mm)
with 27.7° splines



Ex610

Folding extender
(L — 610 mm)
with 27.7° splines

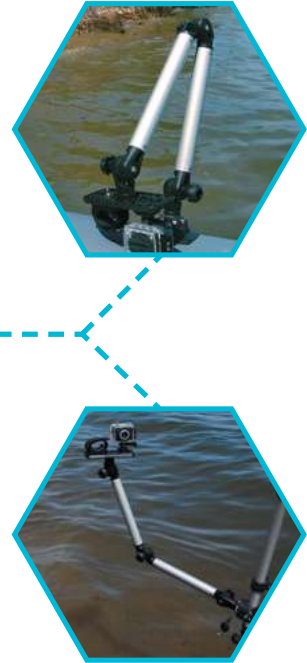

Youtube overview

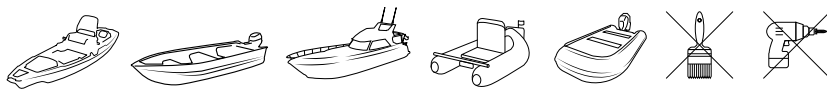

EXTENDERS FOR LIGHT ACCESSORIES

Some tilt accessories have small splines (15°). For example, holders for action cameras and navigation lights, torch holders, or transducer arm mounts. In order to make designs with them, we created these extenders.



Ex150

Extender
(L — 154 mm)
with 15° splines



Ex400

Extender
(L — 305 mm)
with 15° splines

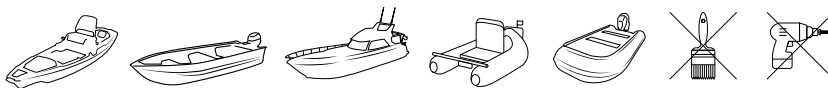



Reel types &
the holder

SPINNING ROD HOLDER

Suits for spinning rods with any type of reel



Youtube overview

Safe securing and quick release

Slot for retriever carabiner

Full adjustment with 7.5° increments



Ht213

Universal spinning rod holder

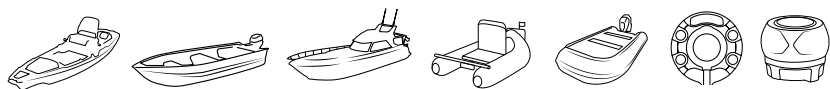

Mounting kits with Ht213 Spinning Rod Holder



Htp213

Mounting kit for inflatable watercrafts
(Ht213 + FMp224)



HTp225

Reinforced mounting kit for inflatables
(Ht213 + FMp225)



HTx213

Mounting kit for the boltrope of PVC watercrafts
(Ht213 + FMx)

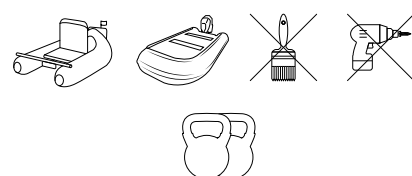

HTa213

Mounting kit for T-Tracks
(Ht213 + FMa)

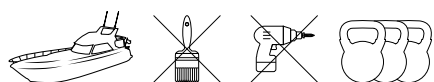

HTs223

Mounting kit for T-Tracks
(Ht213 + Fs223)

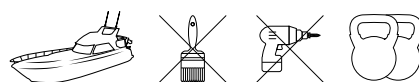



HTb213

Mounting kit for hard deck or side
(Ht213 + FMb)



HTs213

Mounting kit for a T-Track
(Ht213 + Fs218)



* When using in pair with Mp218 or Mp219 mounting pads



HTr213

Mounting kit for Ø 22 or 25 mm tubes and
rails (Ht213 + FMr125)

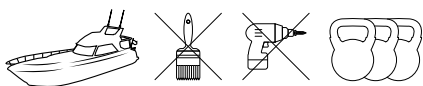

HTr213-2

Mounting kit for Ø 30 or 32 mm tubes and
rails (Ht213 + FMr132)

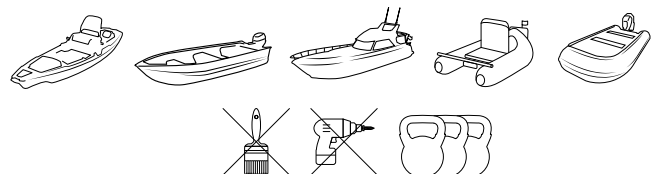

SPINNING RODS HOLDER

These rod racks are used for attaching three spinning rods, which can be fixed in the raised position or in parallel to the water surface.

A close-up photograph of a black spinning rod holder. The holder is mounted on a boat's console. The word "LOWRANCE" is printed in large, bold, white capital letters on the front panel. Below the name, there are two circular ports: a red one on the left and a yellow one on the right. The holder is designed to hold three fishing rods, with one rod visible in the foreground. The background shows a person's hands and a blue mesh net.

LOWRANCE



Rr400-1

Holder for three spinning rods



RRt400

Holders with mounting kit for kayaks (x2 Fs218 mounts)

Rr400

Holders with mounting kit for PVC inflatables (x2 FMp224 systems)



PREMIUM FISH FINDER PLATES

These premium fish finder plates are made of black anodized aluminum. They have a stylish design and even more functionality.

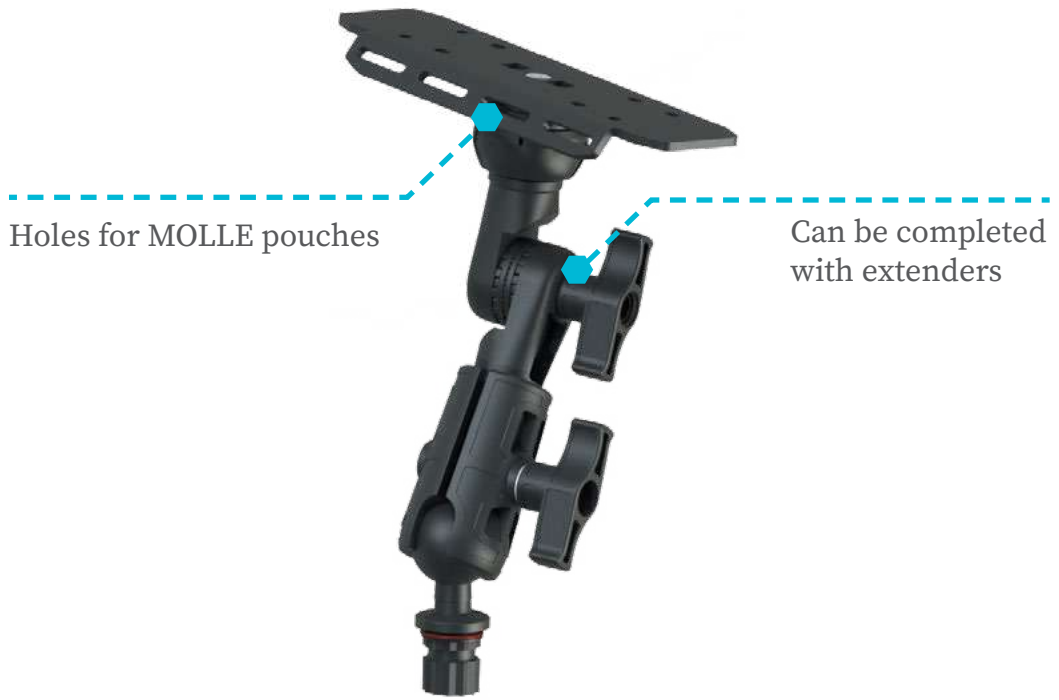

Holes for MOLLE pouches

Can be completed with extenders

SLr220-3
Tilt plate (AL)
for 9" — 12" screen fish finders



Youtube overview



SLr220
Plate
(AL) for 9" — 12" screen fish finders

SLr110
Plate (AL)
for 7" fish finders

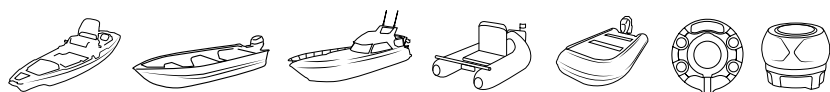

FISH FINDER PLATES



How to install the fish
finder on the plate



How to
install



Ss223
Rotating plate for
7" — 9" fish finders



Sl223
Rotating plate for up
to 7" fish finders



Youtube
overview



Sst223
Swivel-tilt plate for
7" — 9" fish finders



SLt223
Swivel-tilt plate for
up to 7" fish finders



Youtube
overview

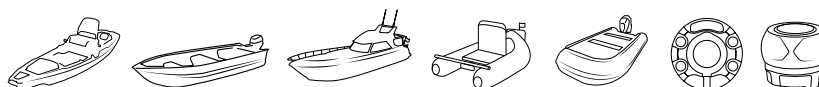

MOUNTING KITS



SLp223

Plate for fish finders up to 7" with the glue-on kit for installation on a PVC inflatable boat (Sl223 + FMp224)



SLTx223*

Plate for fish finders with screen up to 7" with the mounting system for boltrope of PVC boats



SLr223

Plate for fish finders up to 7" with ball & socket joint and the glue-on mounting kit



MOUNTING KITS



SSb223

Plate for 7" — 9" fish finder screens with the kit for installation on the hard deck or side (Ss223 + FMb)



SSp223-1

Plate for 7" — 9" screen fish finders with the kit for installation on the PVC watercrafts (Ss223 + FMp225)

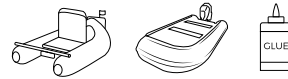

TRANSDUCER ARM MOUNTS

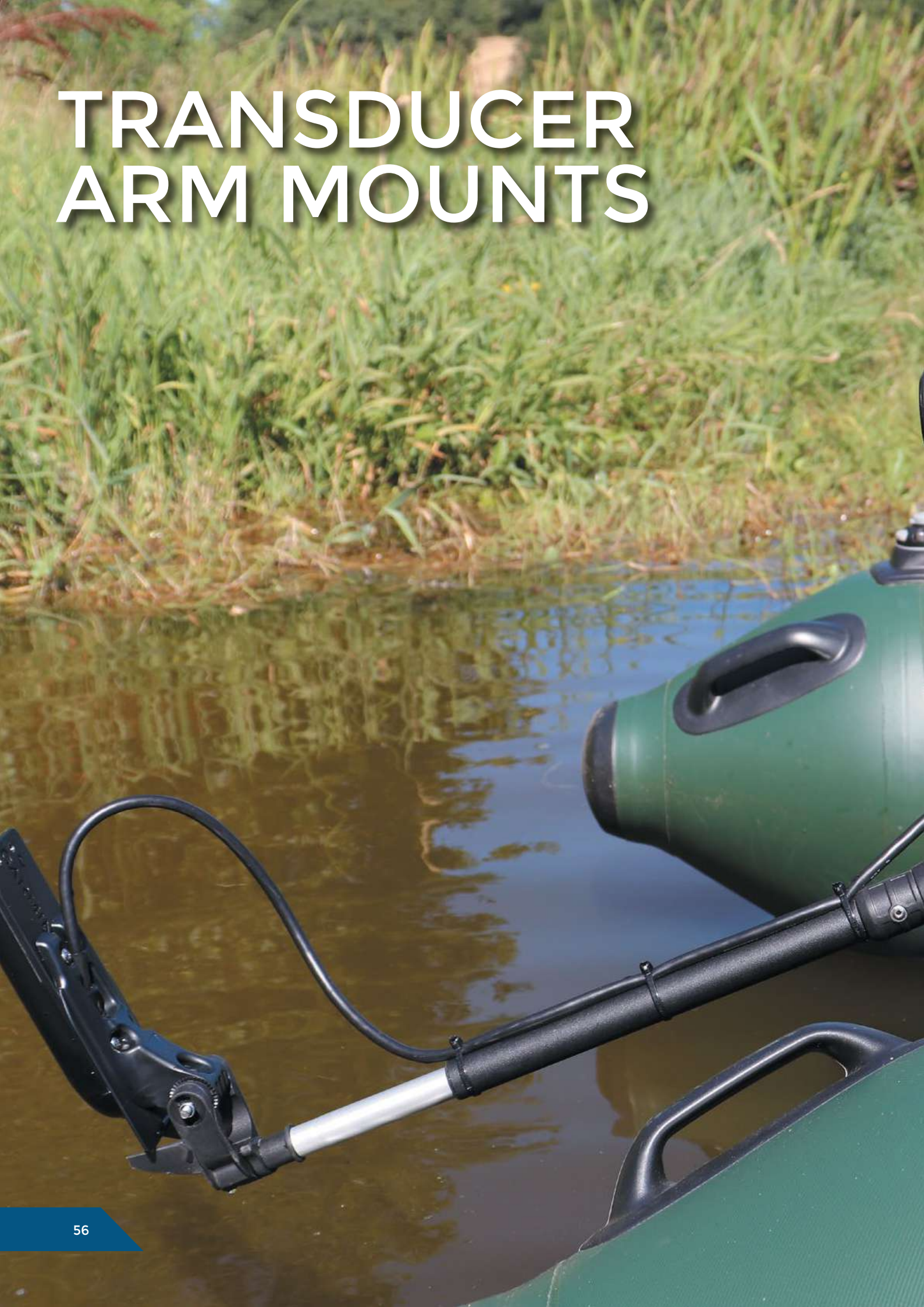



Ft300

Transducer arm mount for a transom (300 mm length)

FIBERGLASS-REINFORCED	PA	ANODISED ALUMINIUM	POWDER COATED	AISI 304
-----------------------	----	--------------------	---------------	----------



FTx300

Transducer arm mount for a boltrope (300 mm length)

FIBERGLASS-REINFORCED	PA	ANODISED ALUMINIUM	POWDER COATED	AISI 304
-----------------------	----	--------------------	---------------	----------



FTTr300

Transducer arm mount for alongside installation (300 mm length)

FIBERGLASS-REINFORCED	PA	ANODISED ALUMINIUM	POWDER COATED	AISI 304
-----------------------	----	--------------------	---------------	----------



Ft500

Telescopic transducer arm mount (max length is 500 mm)

FIBERGLASS-REINFORCED	PA	ANODISED ALUMINIUM	POWDER COATED	AISI 304
-----------------------	----	--------------------	---------------	----------



ON-BOARD KITS FOR FISH FINDER & TRANSDUCER



FTf601

Arm mount with universal set of adapters

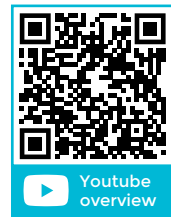

Youtube overview



Ft601

Mounting kit for fish finder and transducer



FTp601

Mounting kit for fish finder and transducer



Youtube overview

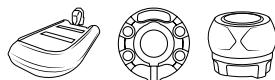

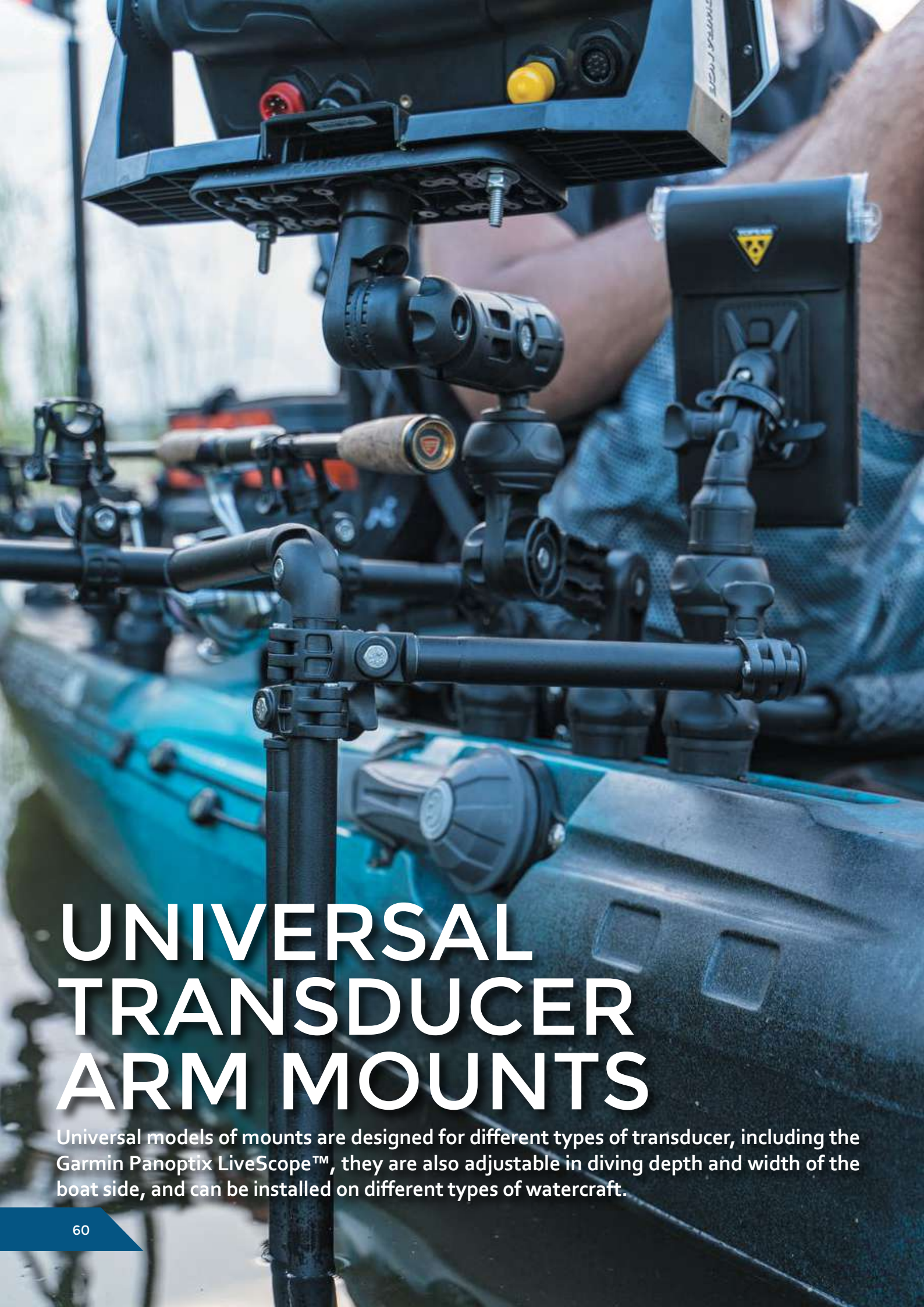

UNIVERSAL TRANSDUCER ARM MOUNTS

Universal models of mounts are designed for different types of transducer, including the Garmin Panoptix LiveScope™, they are also adjustable in diving depth and width of the boat side, and can be installed on different types of watercraft.



LSp400

Fish finder transducer arm mount



Youtube overview

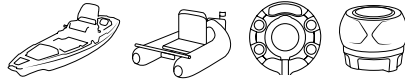

LSp1100

Fish finder transducer holder with mount for a plate



Youtube overview





KITS FOR FISH FINDER & TRANSDUCER

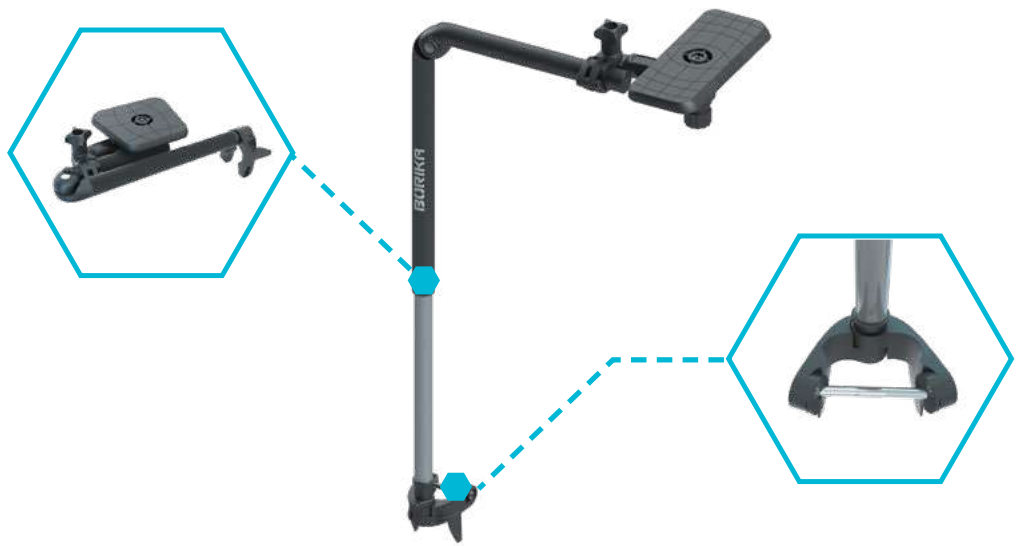

Ft460

Mounting kit for installation of fish finder with 7" — 9" screen and transducer along the side



Ft450

Mounting kit for installation of fish finder with screen up to 7" and transducer along the side

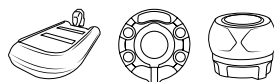

ACTION CAMERA HOLDERS

All of the BORIKA FASTen® action camera holders comprise a 2-to-3 GoPro mounting connector and a bracket with 1/4" threaded mount. This make it possible to secure different types of cameras and capture all the brightest moments of your activities.





Ng005
Action camera
holder



Ng002
Action camera
holder



Ng001
Action camera
holder with
additional mount
for lighting



Ng004
Action camera
holder with flexible
clip for lighting

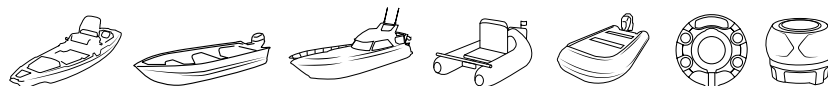

ACTION CAMERA HOLDERS

The Ng1100 monopod has a telescopic design of three sections and allows different types of action cameras be mounted on it. Telescopic struts Lg400 model transform it into a tripod, which reduces vibrations during shooting thanks to more stable construction.



Youtube overview

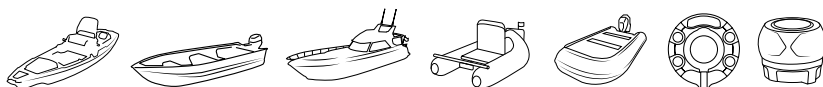

FIBERGLASS-REINFORCED

ANODISED ALUMINIUM

POWDER COATED

AISI 304

ACTION CAMERA HOLDERS



Ng400

Action camera holder in the assembly with extender
(L — 400 mm)

Ng600

Telescopic monopod for action cameras
(L — 710 mm)

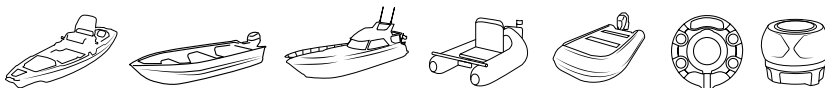
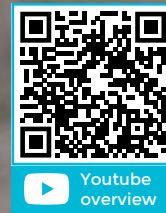

PHOTO & VIDEO EQUIPMENT HOLDERS



For heavier photo and video equipment, reinforced holders are provided. They have a similar design, but differ in the size of threaded mount – 1/4 or 3/8”.





Tp014

Swivel-tilt action, photo and video cameras holder with 1/4" screw-thread mount



Tp038

Swivel-tilt action, photo and video cameras holder with 3/8" screw-thread mount

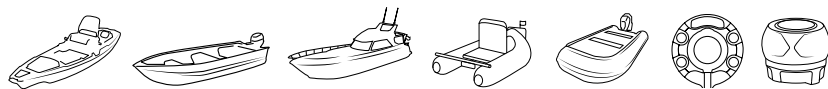

WATERPROOF CASES & HOLDERS



 Youtube
overview



Tp284

Waterproof case for smartphones up to 5" with swivel-tilt holder



Tp285

Waterproof case for smartphones up to 6" with swivel-tilt holder

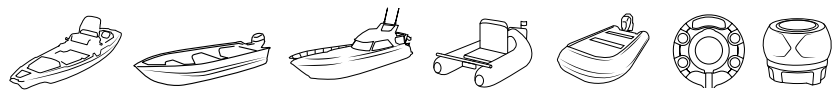

A close-up photograph of a navigation light on a boat. The light is a three-color LED light with a chrome top. In the foreground, a red pennant flag is visible with the text 'B FASTEN ACCESSORIES FOR BOATS'. The background shows a sunset over a body of water with the sun low on the horizon and its reflection on the water.

NAVIGATION LIGHTS

Three-color navigation lights provide visibility of the vessel in poor lighting conditions, which is important, for example, in the early morning or late evening. They can be switched on using a remote control or buttons on the lights. Also, thanks to a special sensor, they automatically turn on when it gets dark. The lights are waterproof and have IP67 protection class.





Red, white & green colours in three modes: light, blinking and SOS

Light sensor for automatically switching on at night



Solar panel for autonomous operation of light

IP67 protection class

Lc003

Portable waterproof navigation light
LONAKO (three-colour)





LFc001

Portable waterproof three-colour navigation light LONAKO with rotating holder (Lc001 + Lf001)



LFc227

Portable waterproof three-colour navigation light LONAKO with a swivel-tilt holder (Lc001 + Lf003)



LFc1100

Portable waterproof three-colour navigation light LONAKO with telescopic holder (Lc001 + Lf1100) L — 1125 mm



Youtube overview

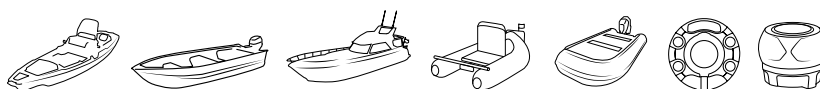



Nd001

Nautical flag with light reflective tape



Nd002

Mount for installation of individual nautical flag on Lf1100 pod or on Ng1100 monopod



Youtube overview

The navigation flag is an important accessory that helps out when there is no navigation light or it doesn't work for some reason. It does not wrap around the tripod in windy conditions. Attaches to the last section of a navigation light arm holder or an action camera monopod (p. 66). Using Nd002 flag mount, you can make your own flag by yourself and install it on the vessel.



Lh130

Swivel-tilt holder for torch





ANCHOR LOCKS & ROLLERS

There are accessories for light (up to 8 kg) and heavy anchors (up to 20 kg).



Youtube overview



AI003

Swivel-tilt anchor lock with automatic stopper



AI004

Reinforced swivel-tilt anchor lock with automatic stopper (for anchors up to 20 kg)



ARr003

Swivel-tilt anchor roller with a guide ring for halyard



ARr004

Reinforced swivel-tilt anchor roller with a guide ring for halyard (for anchors up to 20 kg)





AI002

Anchor lock with automatic stopper

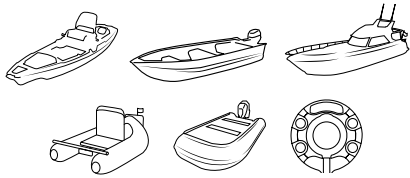

ALp002

Anchor lock with mounting kit for inflatables



ALb003

Tilt anchor lock with mounting kit for rigid boats

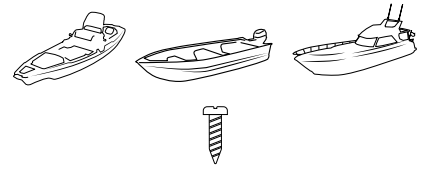

ARr002

Anchor roller with a guide ring for halyard

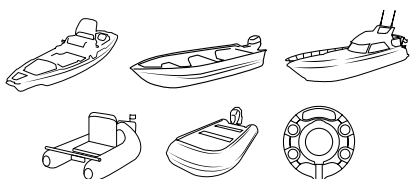

ARRp002

Anchor roller with mounting kit for inflatables



ARRb003

Anchor roller with mounting kit for rigid boats

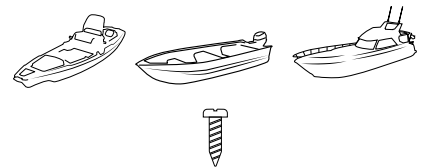

OARS WITH OARLOCKS



PBp140

Oars, set of 2 pcs complete with RLP035 oarlocks (L — 1,4 m, Ø 35 mm)



PBp150

Oars, set of 2 pcs complete with RLP035 oarlocks (L — 1,5 m, Ø 35 mm)



PBp160

Oars, set of 2 pcs complete with RLP035 oarlocks (L — 1,6 m, Ø 35 mm)



Oh032

Retainer for Ø 32 — 35 mm oars and tubes



RLp032

Tube collar / oarlock for Ø 32 mm tubes and oars

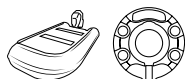

” FISHERMAN’ ASSISTANT” TACKLE PLATE



This is a bait & tackle plate that can be useful for any fisherman and serves as a handy little table that can be adjusted to be close at hand.

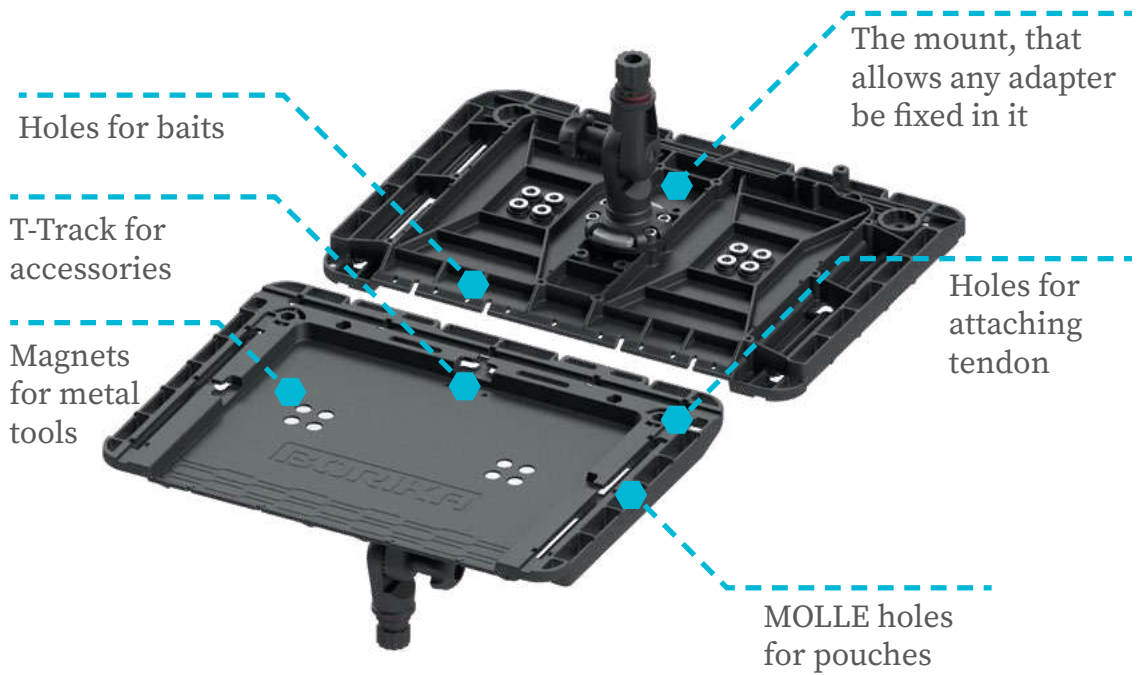

THf375

Multifunctional table



MODULAR TABLES

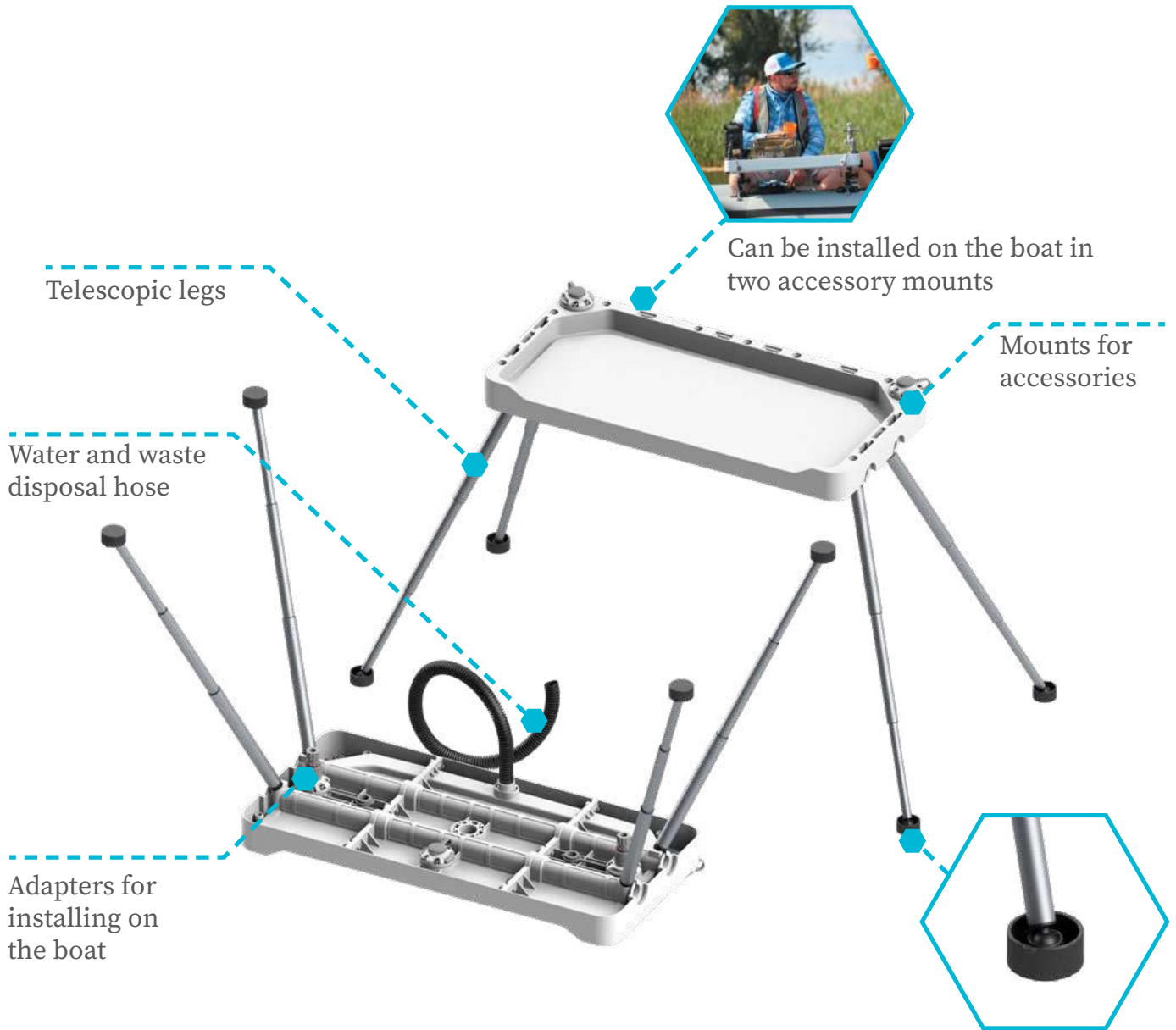

Tm755

Modular table with one additional panel and telescopic legs
(Tm450 + Tm305 + Tm800)



Youtube overview



MODULAR TABLES



Youtube overview



Youtube overview



Youtube overview



Tm450-1

Modular table of two sections



Tm1000

Modular table with two additional sections



Tm305

Extender for modular tables (additional panel)



DRINK HOLDER

This model is much more than just a drink holder. Thanks to the three possible positions of the retainer, it can be used not only to fix cups, mugs, bottles, jars, but also as an additional container for carrying useful gear and as an organizer for hanging tools, baits, and MOLLE pouches.



CUUp

Drink holder with basic organizer functions

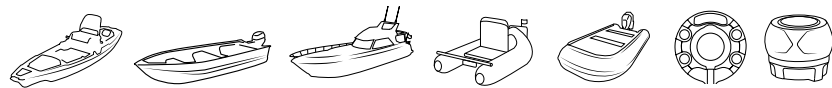

Holes for
MOLLE pouches



T-Track adapter

CUPt

Drink holder with basic organizer functions
complete with T-track adapter

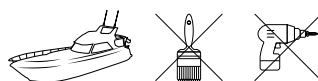



LADDERS

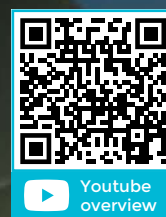

Youtube
overview



Tilt joints for 27.7° increments adjusting

FI032

Folding ladder
1000 mm length



FLp032

Ladder
with mounting kit for
inflatables



EI032

Ladder extender
600 mm length

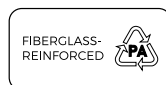

RIGGING TACKLES

The assortment includes various accessories designed for rigging, securing ropes, carabiners, and for mooring. They are designed to make the vessel more comfortable, can be easily fixed into any BORIKA FASTen® mount. Most of them are made as one-piece cast products, that's why they are extremely reliable.



Hm273
Rigging hook



Rm273
Elliptic rigging ring



CFp
Rigging D-ring



Fc229
Mooring bollard

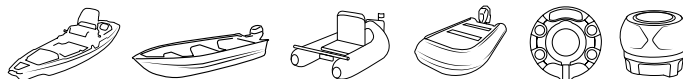



HOLDERS WITH ELASTIC CLIP

They can be used for securing different objects with diameter of 20 to 50 mm. The bracket and clip are made of polyurethane and so are elastic and adjustable.



Rh100

Holder with elastic clip for securing of different objects
Ø from 20 to 50 mm



Rh101

Swivel-tilt holder with elastic clip for securing of different objects
Ø from 20 to 50 mm



Youtube overview

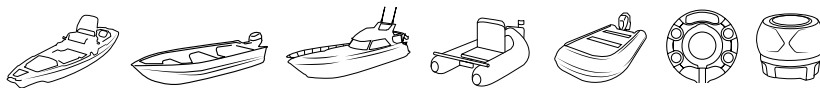

FRh101

Support for boat electric engine arm
Ø up to 50 mm



Youtube overview

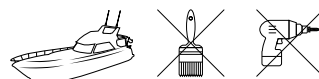

A close-up photograph of a black PVC mount on a boat. A red and white braided rope is threaded through a D-ring at the top. Below it, a blue handle is attached to the mount. The mount is secured to a surface with several screws. The background is a blurred blue and white surface, likely the hull of a boat.

RINGS & HANDLE ON PVC GASKETS

PVC mounts complete with D-rings, towing rings and handles fit under the Fs219 mount, which is attached to the mounting pad with four screws. To do this, you need to disconnect the mount and the pad, then install the PVC gasket between them, insert the screws into the mount, attaching the mount to the pad. Such devices help to save space on the watercraft and are actively used on inflatable boats, belly boats and even fishing kayaks.



Pr201
D-Ring



Pr203
Two D-Rings



Pt205
Towing Ring



Ph206
Towing Handle



PHr204
Towing Handle and Ring



MOLLE POUCHES FOR TOOLS & TACKLES

These bags are made of PVC fabric and have straps, similar to MOLLE modular system, that allow them to be fixed at accessories with paired oblong holes, such as plate "Fishman's assistant", some plates for fishfinder or drink holder.





Bm181
Pouch, Size XS
114 x 99 x 40 mm



Bm182
Pouch, Size S
153 x 99 x 42 mm



Bm183
Pouch, Size M
161 x 99 x 40 mm



Pm255
MOLLE PVC mount for
TRk255 pad



Pm150
MOLLE PVC mount for
TRk150 pad



Pm219
MOLLE PVC mount for
Fs219 adapter



Pm218
MOLLE mount for
Fs218 mount

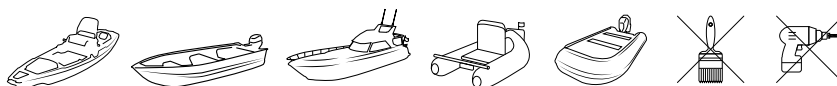

PVC
FABRIC

ADAPTERS & JOINTS



Hr228

Set of halyard holders for installation under Fs219 mount



Hb228

Set of strap holders for installation under Fs219 mount



As222

Reinforced adapter with double side 27.7° splines in the assembly with rigging shackle



As221

Adapter with 27,7° side splines



Af221

Adapter with fastener



Ah264

Rotating adapter with 30° external splines for connecting of two mounts



ADAPTERS & JOINTS



Ah265

Adapter with 30° external splines for connecting of two mounts



Ac001

Adapter for securing of carp fishing tackle



Kn226

Tetrahedral plastic handle-nut with T-bolt



Tf256

Awning fork with armored rotating adapter



Tf255

Awning cardan joint for Ø 22 mm tube constructions



TFp254

Awning cardan joint for installation of Ø 22 mm and 32 mm tube constructions



COOPERATION WITH MANUFACTURERS

Our company provides a full production cycle, from idea to producing. We have a design department that has been developing equipment for boat manufacturers around the world for many years. Our partners can choose from standard models (the range is very large: oars and oarlocks, transom accessories, handles, anchor locks and much more) or order the development of special equipment in accordance with their specifications and with their own logo.



The example of
innovative components
for an inflatable boat



Vitalii Borysenko &
his offer for manufacturers

